

Home Storage Solutions



**WE WILL
DELIVER**



**WE WILL
ASSEMBLE**



**SPECIAL
ORDERS**

LUGNA
FORM & FUNCTION

Available at
BUNNINGS
warehouse

Take This Brochure to the Special Orders Desk or order online at [bunnings.com.au](https://www.bunnings.com.au)

LUGNA

FORM & FUNCTION

PRODUCT RANGE

Inspired by European design, Lugna is a range of home storage solutions, available in five colours. The range includes floor and wall-mounted cabinets, drawers, shelves and hinged doors. Designed to allow you to create a bespoke entertaining, walk-in wardrobe or home office space on any budget.



Measure your Space

Accurately measuring your space is crucial before adding modular cabinets to ensure a seamless fit and maximise functionality.

STEP 1

STEP 2

STEP 3

3D Planner

Scan the QR code to design and plan your dream room using the Lugna home storage solutions range. Create your room to size, add cabinets in your desired depth, width, and height. Drag and drop more cabinets, shelves, drawers, doors, and hanging rails to complete your project.

SCAN TO PLAN
Plan your space with our online planner



Colour Range

White is available in-store. All other colours must be ordered at the Special Orders Desk or Online.



Sand



Mist



Storm



Cove



White

STEP 1 Start with a Cabinet Shell

Cabinet Shell

Select the cabinet shell to suit your project. Combine cabinet shells to optimise space, from floor to ceiling and from wall to wall.

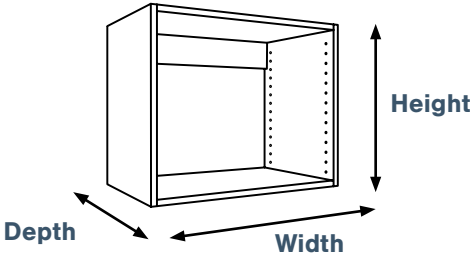

3 Depths

280mm
 Magazines
 Entertainment storage
 Books

380mm
 Stacks of clothes
 Board games

580mm
 Hangers
 Stacks of clothes

4 Widths

450mm
 1 Stack of clothes
 2 Pairs of shoes

600mm
 2 Stacks of clothes
 3 Pairs of shoes

750mm
 3 Stacks of clothes
 4 Pairs of shoes

900mm
 4 Stacks of clothes
 5 Pairs of shoes

5 Heights

512mm

768mm

1024mm

1536mm
 1 Fixed shelf

2048mm
 1 Fixed shelf



STEP 2 Choose Shelves & Drawers

Adjustable Shelf - 2 Pack

Lugna's adjustable shelves are compatible with any cabinet size, allowing you to optimise your storage.

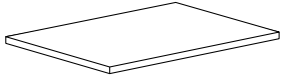

External Drawer

Lugna drawers feature soft-close runners, and a modern lip pull handle. Personalise your design with alternate handles and knobs.

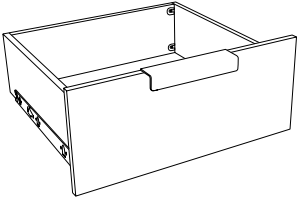

Scallop Drawer

The scallop drawer features soft-close runners and a handle-free design. Great for kids, easy and safe for everyone to use, with a unique look and feel.

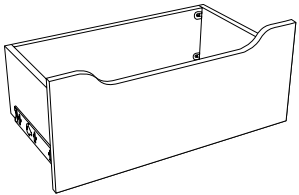

Inner Drawer

Featuring soft-close runners, the inner drawer is ideal for storage behind doors.

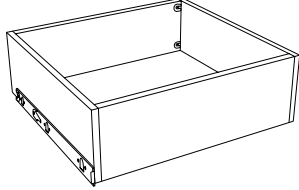

Shelves available for all depths. Drawers only available for 380mm & 580mm depths.

STEP 3 Finish off with Accessories

Handles

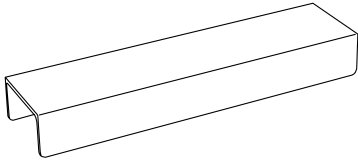

The following handles come standard with each cabinet colour.	
Gold	Sand
Black	White, Cove, Storm
Silver	Mist
White	Available to order

All handles colours are available to order.

Hanging Rail

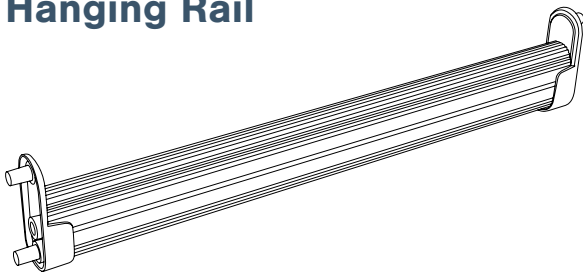

Choose from 3 colours and 4 widths.

Width	450mm	600mm	750mm	900mm
--------------	-------	-------	-------	-------



Doors

Lugna cabinet doors come with modern lip pull handle. Personalise your design with alternate handles and knobs. All doors have a depth of 16mm. Designed to fit our range of cabinets, mix and match doors with drawers to maximise your accessibility and design.

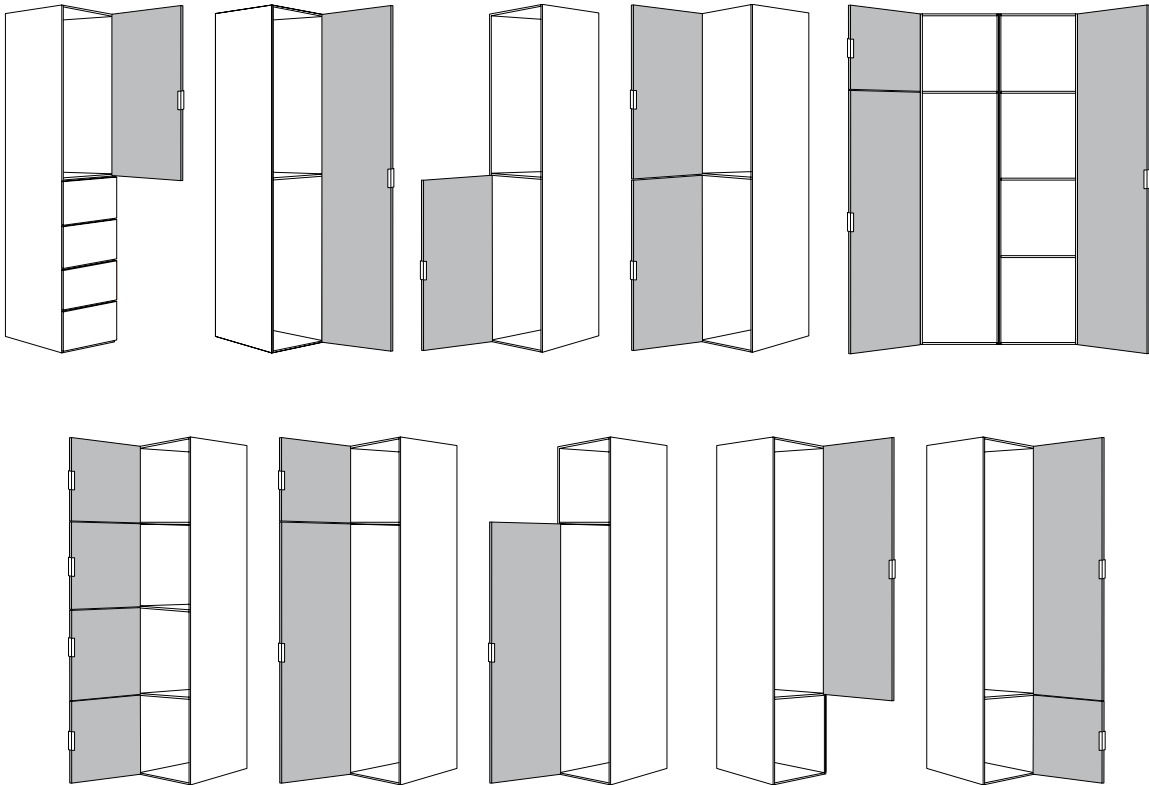

Single Doors – Left or Right Opening
Available in all heights in 450 or 600 width.

Double Doors – Left & Right included
Available in all heights to fit cabinets 600, 750, 900 wide.

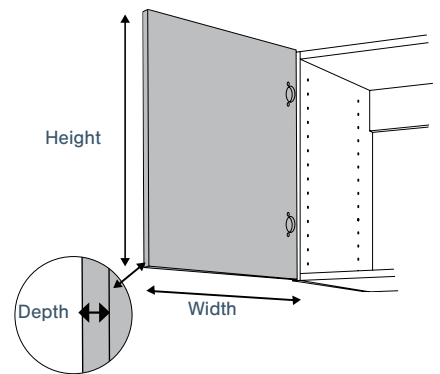

Hinges

Soft close hinges for doors are sold separately – choose from 2 types.

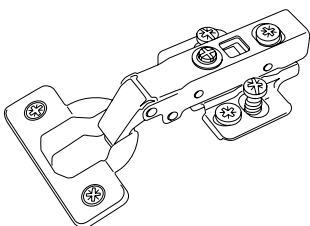

110° Hinge - 2 Pack

Suitable for applications with no internal drawers.

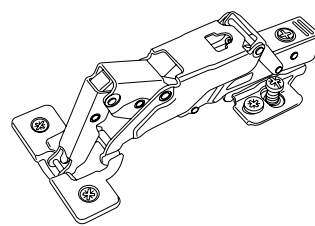

165° Hinge - 2 Pack

Suitable for applications with internal drawers behind a door.



INSPIRATION



Here are some ideas to get you started with simple inserts to upgrade your bedroom, living room or general storage.



768H x 600W x 380D
 1x Cabinet Shell I/N: 0431297
 3x Drawers I/N: 0430710



1536H x 600W x 380D
 1x Cabinet Shell I/N: 0430599
 2x Adj Shelves 2pk I/N: 0430838



1536H x 600W x 380D
 1x Cabinet Shell I/N: 0430599
 1x Adj Shelves 2pk I/N: 0430838
 3x Drawers I/N: 0430710

- Easy DIY Assembly
- Modular Design
- Trade Quality Finish
- High Moisture Resistant Board
- Scratch & Stain Resistant

LUGNA
 FORM & FUNCTION

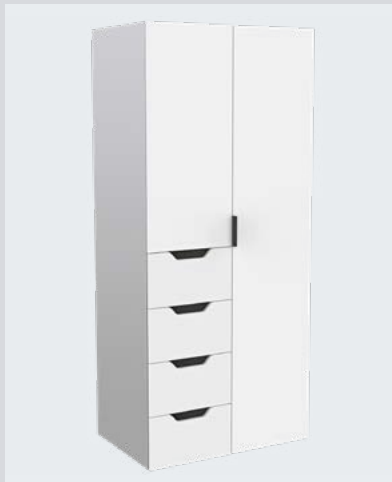

2048H x 900W x 580D
 1x Cabinet Shell I/N: 0430513
 4x Scallop Drawers I/N: 0430661
 1x Door Right I/N: 0430792
 1x Door Left I/N: 0430754
 3x Hinge 110 I/N: 0431437

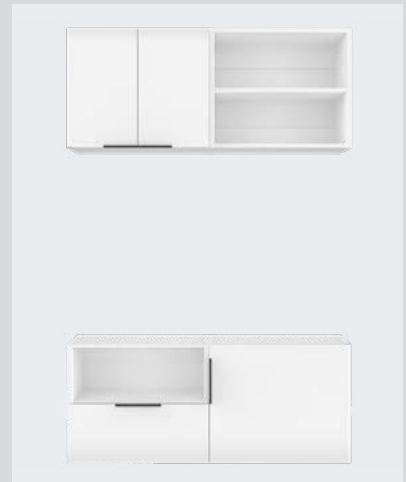

2 x 512H x 1200W x 380D
 4x Cabinet Shell I/N: 0431420
 2x Adj Shelves 2pk I/N: 0430838
 1x Dbl Doors I/N: 0430549
 1x Door Right I/N: 0431283
 1x External Drawer I/N: 0430710
 3x Hinge 110 I/N: 0431437

How It Works

It's as simple as 1,2,3! Follow the steps shown to purchase or order your product. If you need further advice, speak to a team member at the Special Orders Desk in-store.

1. Select The Product You Want

View the extensive range available in this brochure or online. Use the number shown below to order your product online or in-store.

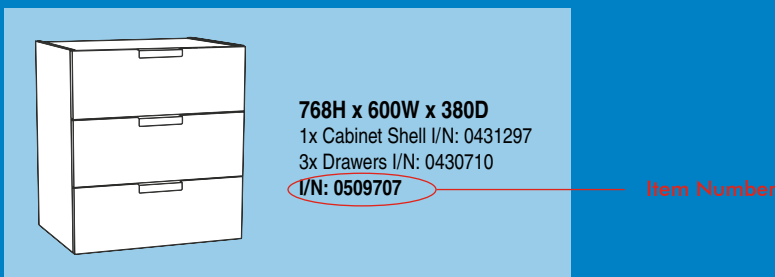

2. Order Online or at the Special Orders Desk

After you have selected the product you want, take this brochure to the Special Orders Desk or order online at [bunnings.com.au](https://www.bunnings.com.au)

3. Get It Home

We Will Deliver

Delivery to your home or site can be arranged online or in-store when purchasing your products.

Pick-Up In-Store

If you decide to pick-up in-store and need help to get it home, you can:

- borrow a courtesy trailer
- hire a vehicle

Check with your local Bunnings store for availability.

